

# tBOX330-870-FL

Fanless Embedded System with 3rd Generation Intel® Core™ Processor and Intel® QM77 for Marine PC

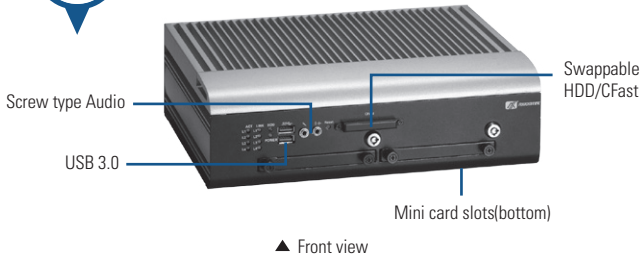

▲ Front view

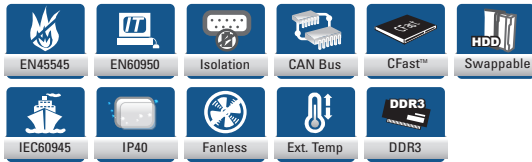

## Specifications

Standard Color	Silver-Black				
Construction	Aluminum extrusion and heavy-duty steel, IP40				
CPU	3rd Generation Intel® Core™ i processor ; 3rd Gen. Intel® Core™ i7-3517UE (1.7 GHz up to 2.8 GHz) or 3rd Gen. Intel® Core™ i3-3217UE (1.6 GHz)				
System Memory	DDR3-1600 4 GB DRAM				
Chipset	Intel® QM77				
BIOS	AMI UEFI BIOS with OA 3.0 built				
System I/O Outlet	<table border="0"> <tr> <td>Rear Side</td> <td>                     4 x GbE LAN (M12 A-coded)                      3 x isolated RS-232/422/485                      1 x isolated DI/DO (4-in/4-out)                      1 x isolated CAN Bus                      2 x USB 2.0                      2 x audio (mic-in/line-out, screw type)                      1 x VGA                      1 x DVI-D                      1 x VDC power input                      1 x remote power switch                      4 x antenna opening                 </td> </tr> <tr> <td>Front Side</td> <td>                     2 x USB 3.0                      2 x audio (mic-in/line-out, screw type)                      1 x reset switch                      2 x 2.5" SATA drive trays                      1 x CFast™ slot                 </td> </tr> </table>	Rear Side	4 x GbE LAN (M12 A-coded) 3 x isolated RS-232/422/485 1 x isolated DI/DO (4-in/4-out) 1 x isolated CAN Bus 2 x USB 2.0 2 x audio (mic-in/line-out, screw type) 1 x VGA 1 x DVI-D 1 x VDC power input 1 x remote power switch 4 x antenna opening	Front Side	2 x USB 3.0 2 x audio (mic-in/line-out, screw type) 1 x reset switch 2 x 2.5" SATA drive trays 1 x CFast™ slot
Rear Side	4 x GbE LAN (M12 A-coded) 3 x isolated RS-232/422/485 1 x isolated DI/DO (4-in/4-out) 1 x isolated CAN Bus 2 x USB 2.0 2 x audio (mic-in/line-out, screw type) 1 x VGA 1 x DVI-D 1 x VDC power input 1 x remote power switch 4 x antenna opening				
Front Side	2 x USB 3.0 2 x audio (mic-in/line-out, screw type) 1 x reset switch 2 x 2.5" SATA drive trays 1 x CFast™ slot				
Watchdog Timer	255 levels, 0 ~ 255 sec.				
Storage	2 x 2.5" SATA HDD (Removable and with lock protection) supports RAID 0/1 1 x CFast™				
Expansion Interface	3 x PCI Express Mini Card 1 x SIM card slot				
System Indicator	1 x green LED for system power on 1 x blue LED for HDD active 1 x green LED for LAN1 link 1 x green/yellow LED for LAN 1 speed 1 x green LED for LAN2 link 1 x green/yellow LED for LAN 2 speed 1 x green LED for LAN3 link 1 x green/yellow LED for LAN 3 speed 1 x green LED for LAN4 link 1 x green/yellow LED for LAN 4 speed				

## Features

- IEC60945 certificate
- Comply to fire protection of railway vehicles Europe standard PrCEN TS 45545-2
- 3rd Generation Intel® Core™ i7 1.7 GHz up to 2.8 GHz or Intel® Core™ i3 1.6 GHz processor
- High performance DDR3-1600 4 GB memory onboard
- Fanless with operating temperature range of -40°C ~ +70°C
- Isolated RS-232/422/485, CAN bus and DIO ports
- Supports USB 3.0 and SATA3 interface
- 2 removable & lockable 2.5" SATA HDD and 1 CFast™
- 3 internal PCI Express Mini Card slot and 1 SIM slot

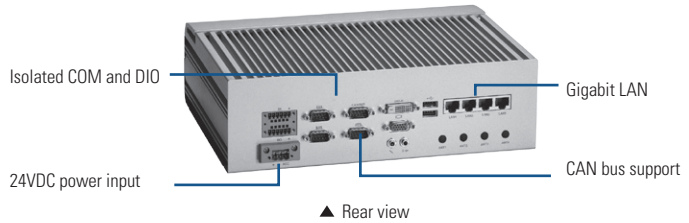

▲ Rear view

Power Supply	Power input : 14~32VDC, Typical 24VDC
Power Consumption	1.8A @ 24V
Operating Temperature	-40°C ~ +70°C (-40°F ~ +158°F) W/T SSD -25°C ~ +55°C (-13°F ~ +131°F) W/T HDD
Storage Temperature	-40°C ~ +80°C (-40°F ~ +176°F)
Humidity	5% ~ 95%, non-condensing
Vibration Endurance	5 Grms with CFast™ (5-500Hz, X, Y, Z directions) 1 Grms with HDD (5-500Hz, X, Y, Z directions)
Dimensions	288 mm (11.33") (W) x 211 mm (8.3") (D) x 85.7 mm (3.37") (H)
Weight (net/gross)	5.5 kg (12.12 lb)/6.5 kg (14.33 lb)
Certificate	CE (Class A), IEC60945 certificate, EN45545-2 compliance
EOS Support	WEBS, WES 7, Linux

## Ordering Information

### Standard

tBOX330-870-FL-i7-DC	Fanless embedded system with 3rd Generation Intel® Core™ i7 processor, 4GB DDR3-1600, 4 GbE LAN, 3 isolated COM, CFast™, 1 isolated CAN bus
----------------------	---

### Optional

2.5" SATA HDD/SSD	16 GB or above
CFast™	1 GB or above
3G module	
Wi-Fi module	
Wi-Fi Bluetooth	
GPS module	

\*Specifications and certifications are based on options and may vary.

## Expansion & Installation

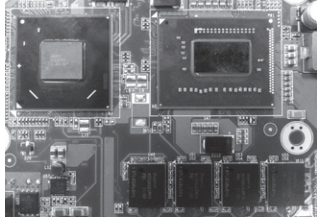

Onboard 3rd Gen. Intel® Core™ i7 or i3 processor and 4 GB DDR3-1600 DRAM



Swappable and Lockable SATA3 HDD/SSD, Audio jack, USB 3.0 and CFast

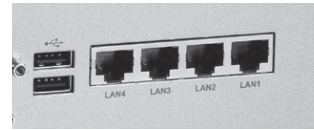

Four Gigabit LAN ports

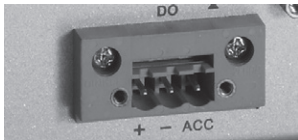

24VDC power input

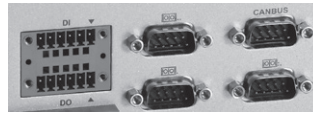

Isolated RS-232/422/485, CAN bus and DIO

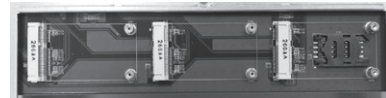

3 PCIe Mini Card slots with 1 SIM slot

### Packing List

- 1 x quick manual
- 1 x driver CD
- 1 x screw pack
- 4 x foot pad
- 1 x wall-mount kit

### Power Protection

#### DC Version

- SCP (short circuit protection)
- OVP (over voltage protection)
- UVP (under voltage protection)

### Dimensions

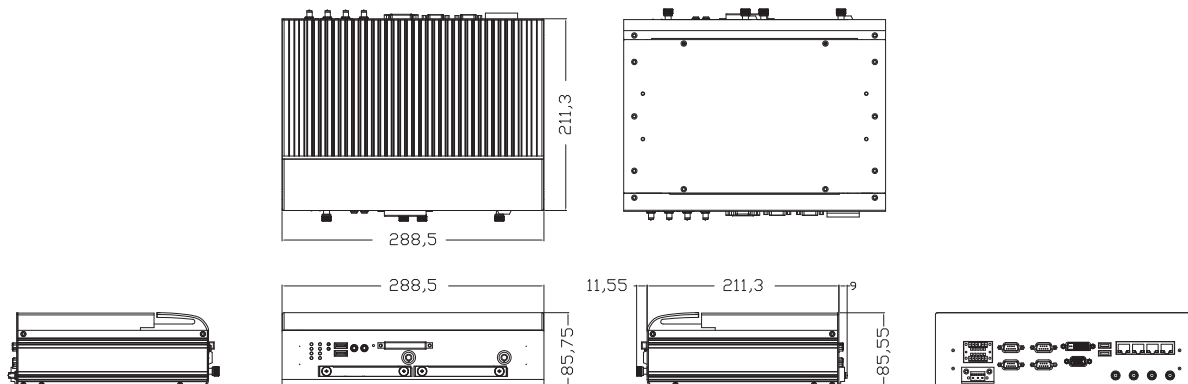

\* All specifications and photos are subject to change without notice.

